

LUNA PERGOLA

tempo
Beauty of aluminium

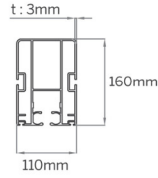

① Rafter

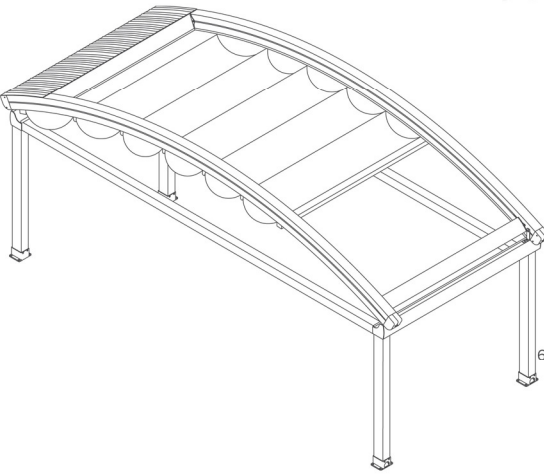
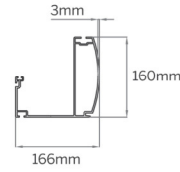

② Gutter

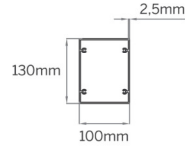

③ Post

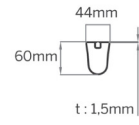

④ FabricSupport (Standart)

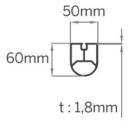

④ FabricSupport (HDD Lux)

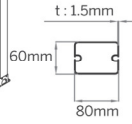

⑤ Puller Profile (Standart)

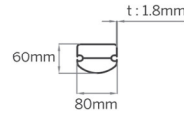

⑤ Puller Profile (HDD Lux)

SYSTEM COUPLING OPTIONS

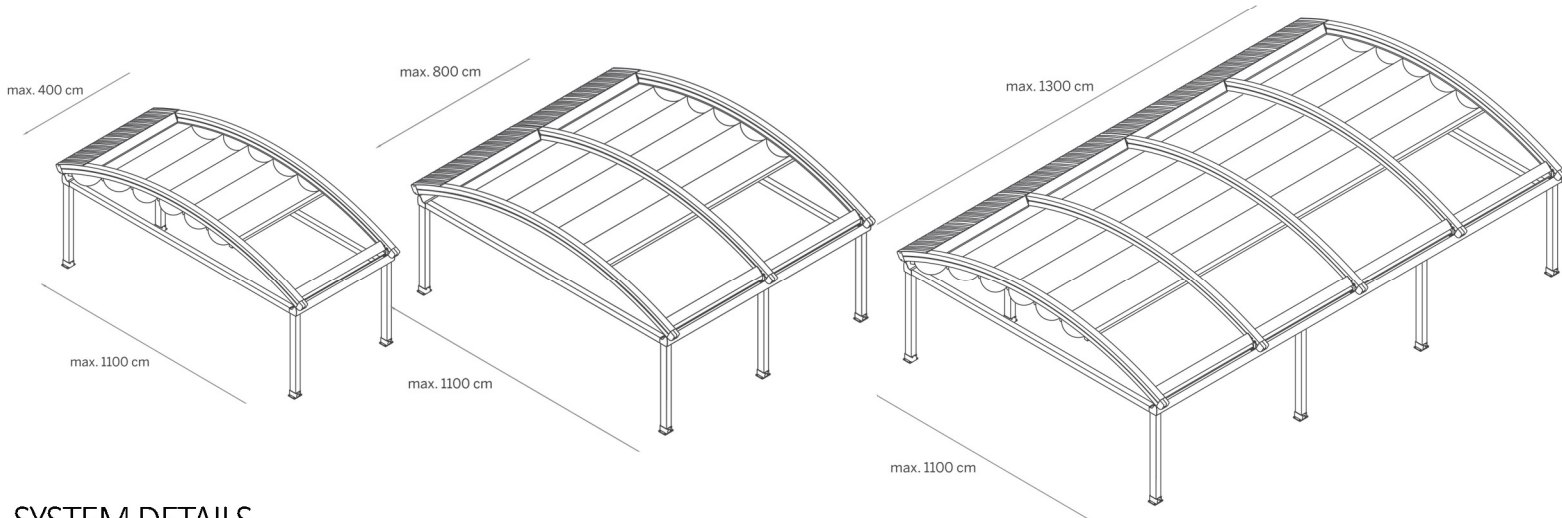

SYSTEM DETAILS

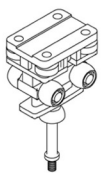

F3 Eight wheel slider

Four horizontal & four vertical rollers working together for perfectly smooth operation every time. The F3 eight wheel system is proven to remove the jamming issue that occurs with the 4 wheel system and can take loads of upto 600KG.

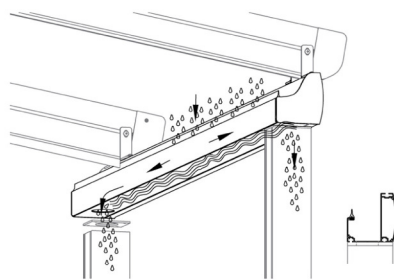
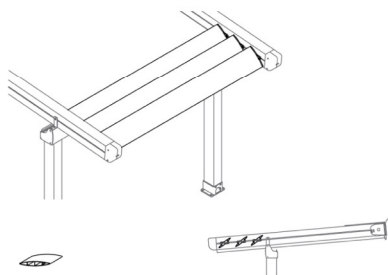

Integrated gutter & internal drainage system

The integrated gutter system provides the perfect solution for water drainage.

Compact 26rpm direct drive motor box

The Suntech direct drive motor system is a quick and efficient system that drives all conveyor rafters at the same time. The low profile design also allows the fabric to be stored underneath the motor which saves additional space.

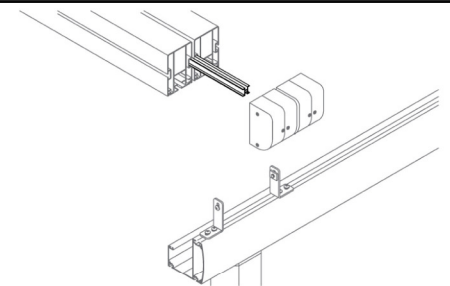

Storm channel for joining system

The storm channel is patented solution for joining two systems side by side with a waterproof join.

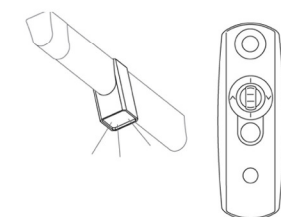

LED-TEC dimmer setup

LED-TEC dimmer lighting is a integrated lighting solution that can be added to any Suntech system.

Aerofoil Louvres

The addition of Aerofoil louvres can provide added shade when the system is closed.